

Quantum Information Processing with Semiconductor Quantum Dots

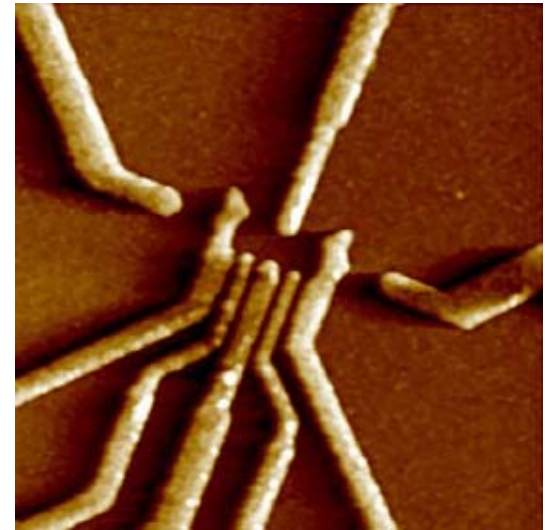

slides courtesy of Lieven Vandersypen, TU Delft

*Can we access the quantum world
at the level of single-particles?
in a solid state environment?*

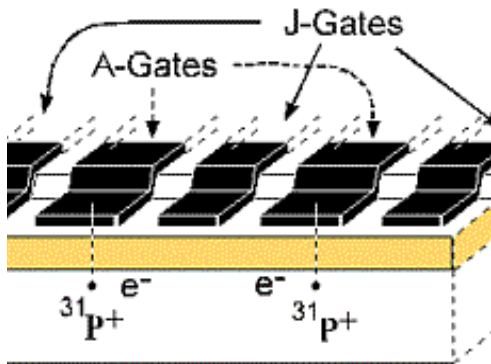

Kane, Nature 1998

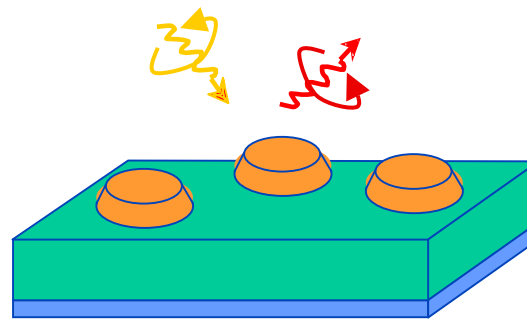

Imamoglu *et al*, PRL 1999

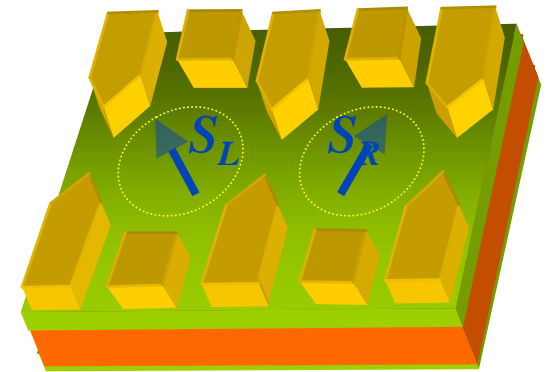

Loss & DiVincenzo
PRA 1998

Electrically controlled and measured quantum dots

A small semiconducting (or metallic) island where electrons are confined, giving a discrete level spectrum

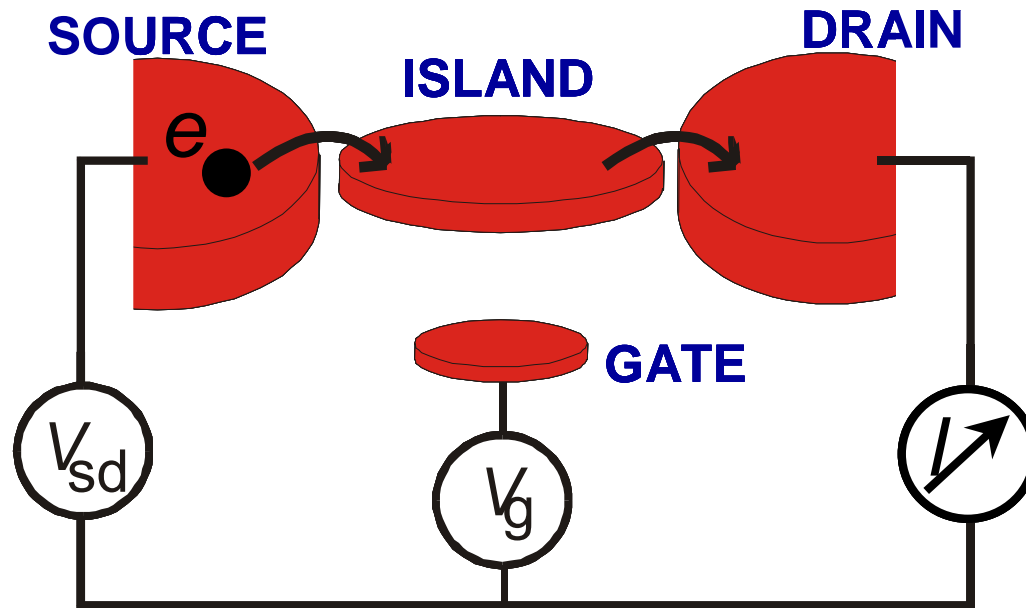

- Coupled via tunnel barriers to source and drain reservoirs
- Coupled capacitively to gate electrode, to control # of electrons

Examples of quantum dots

single molecule

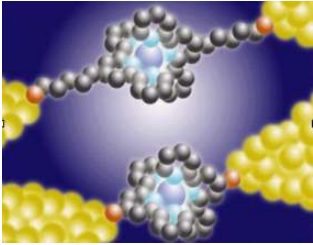

self-assembled QD

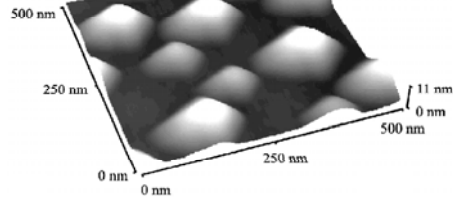

lateral QD

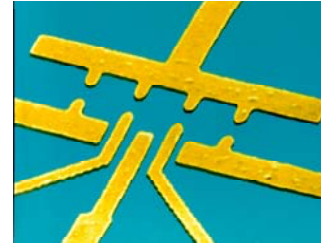

nanotube

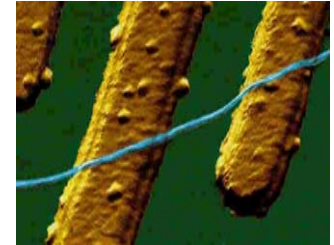

1 nm

10 nm

100 nm

1 μ m

metallic nanoparticle

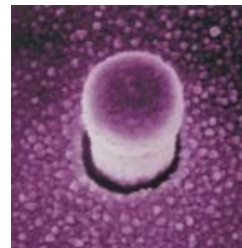
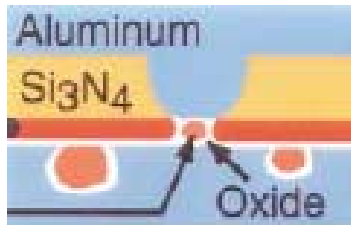

vertical QD

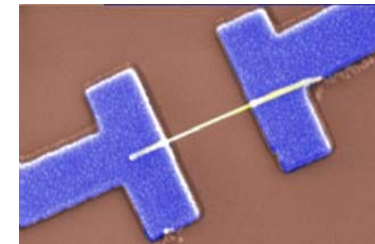

nanowire

Electrostatically defined quantum dots

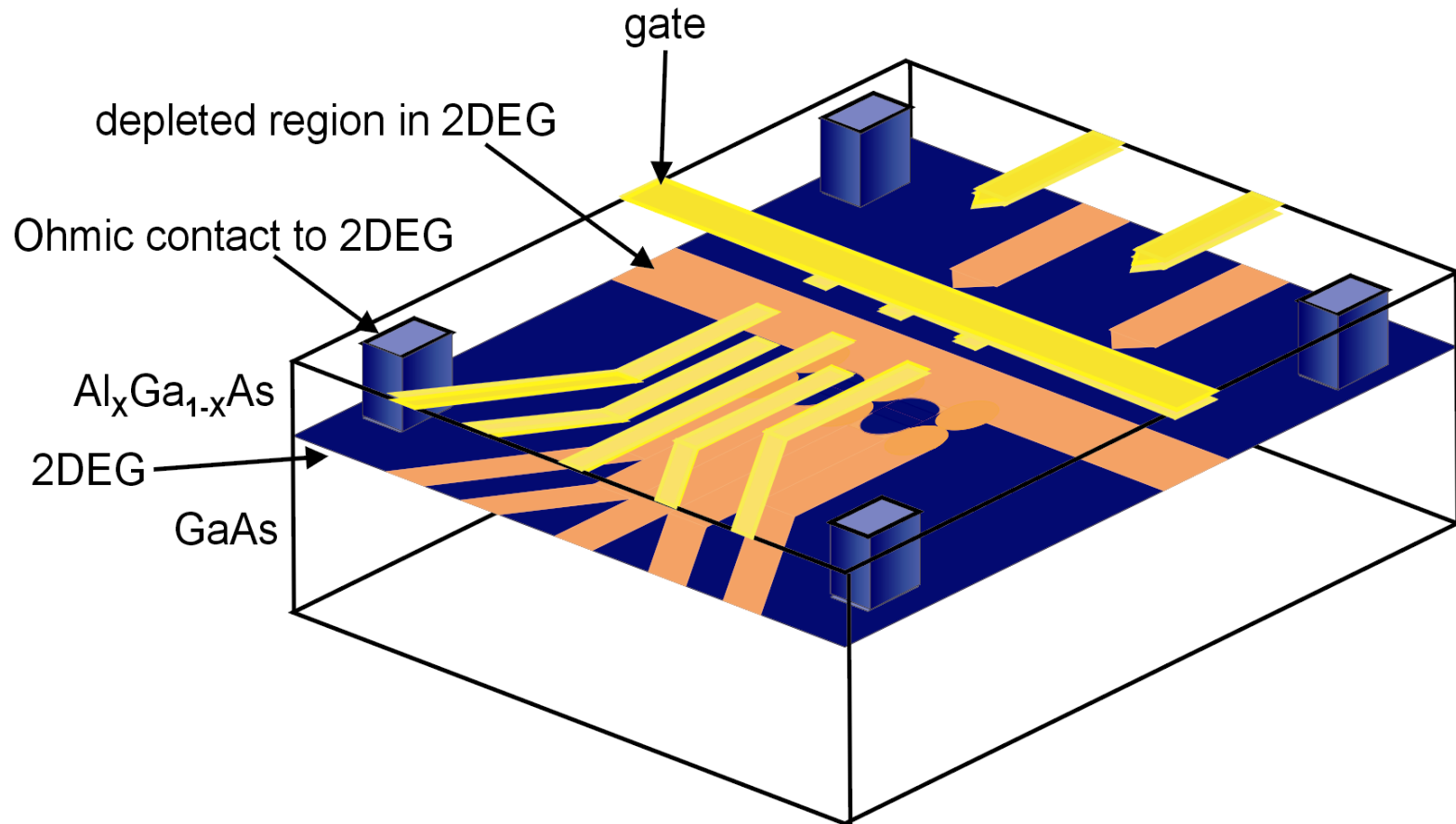

- Electrically measured (contact to 2DEG)
- Electrically controlled number of electrons
- Electrically controlled tunnel barriers

Spin qubits in quantum dots

Loss & DiVincenzo, PRA 1998

Vandersypen et al., Proc. MQC02 (quant-ph/0207059)

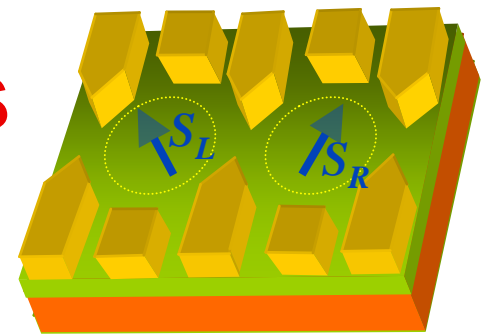

Initialization 1-electron, low T , high B_0

$$H_0 \sim \sum \omega_i \sigma_{zi}$$

Read-out convert spin to charge
then measure charge

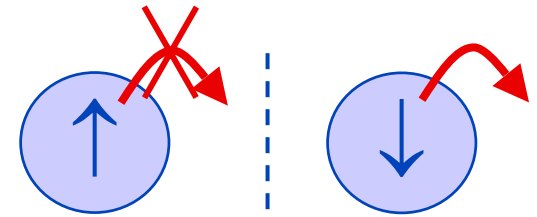

ESR pulsed microwave magnetic field

$$H_{\text{RF}} \sim \sum A_i(t) \cos(\omega_i t) \sigma_{xi}$$

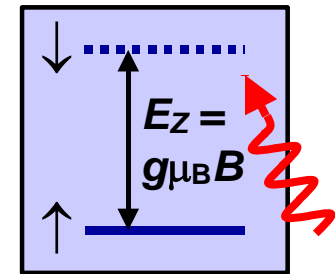

SWAP exchange interaction

$$H_J \sim \sum J_{ij}(t) \sigma_i \cdot \sigma_j$$

Coherence long relaxation time T_1
long coherence time T_2

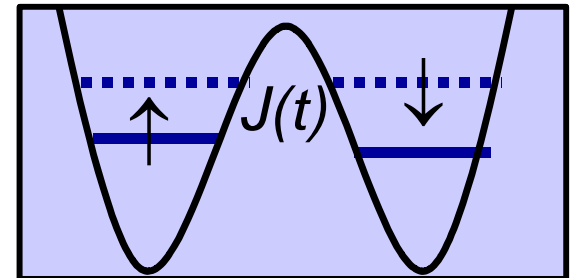

Spin qubits in quantum dots

Loss & DiVincenzo, PRA 1998

Vandersypen et al., Proc. MQC02 (quant-ph/0207059)

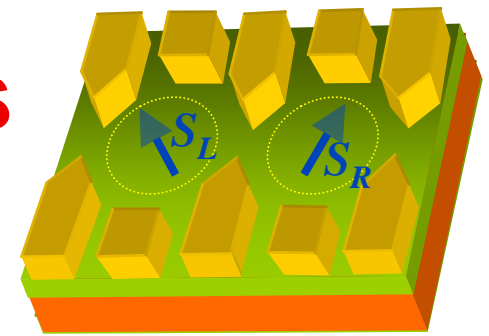

Initialization 1-electron, low T , high B_0

$$H_0 \sim \sum \omega_i \sigma_{zi}$$

Read-out convert spin to charge
then measure charge

ESR pulsed microwave magnetic field

$$H_{\text{RF}} \sim \sum A_i(t) \cos(\omega_i t) \sigma_{xi}$$

SWAP exchange interaction

$$H_J \sim \sum J_{ij}(t) \sigma_i \cdot \sigma_j$$

Coherence long relaxation time T_1
long coherence time T_2

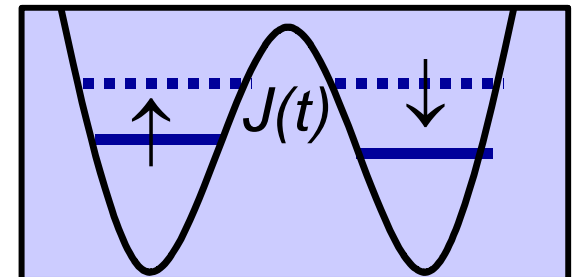
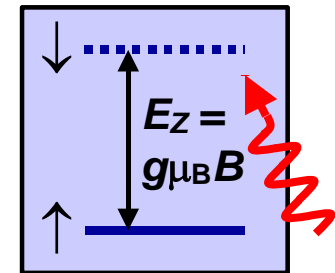
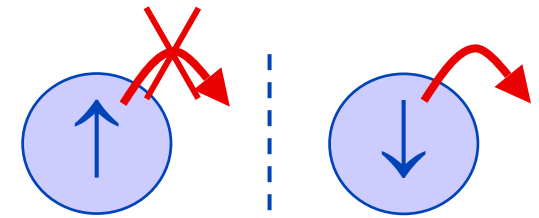

Transport through quantum dot - Coulomb blockade

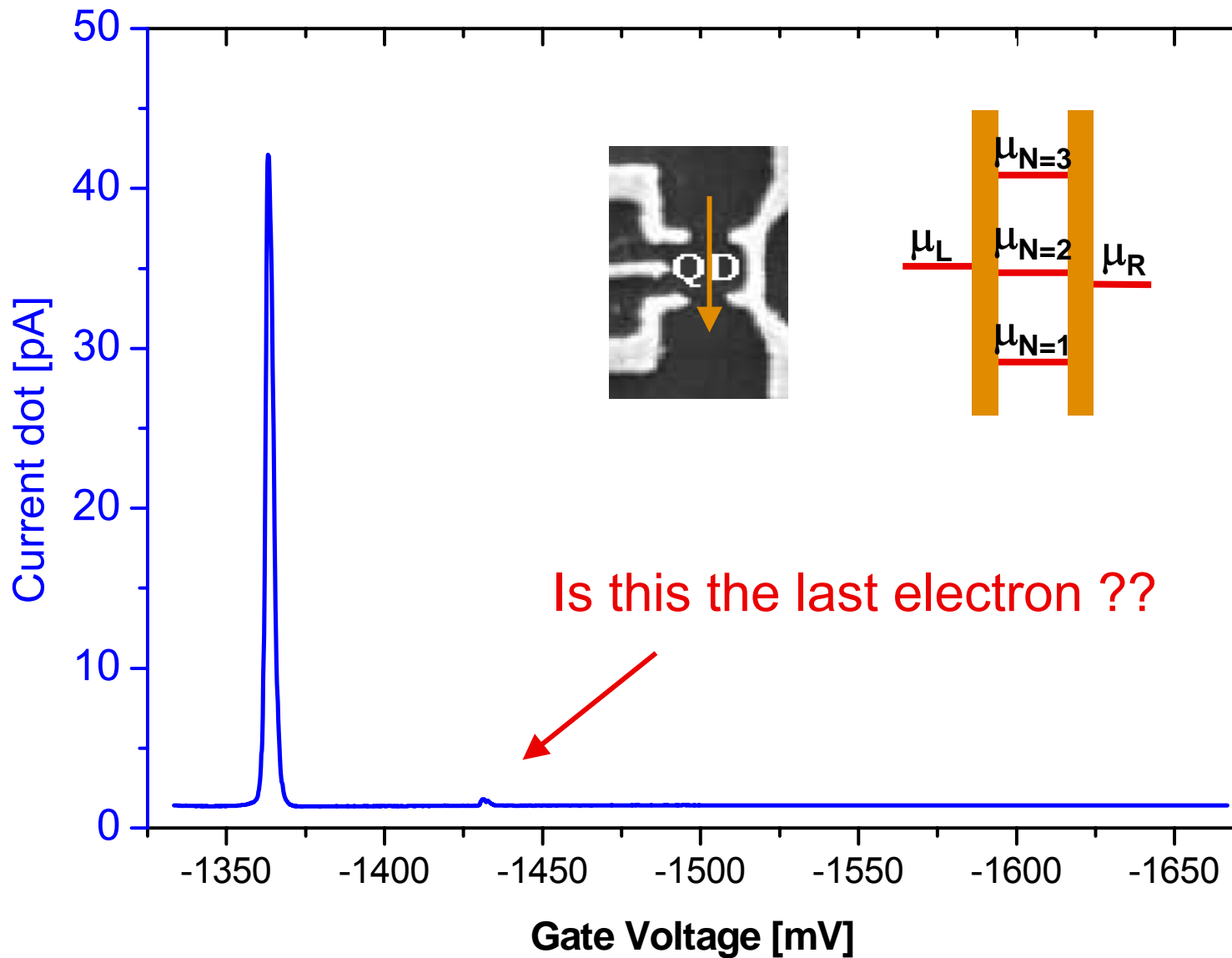

A quantum point contact (QPC) as a charge detector

Field *et al*, PRL 1993

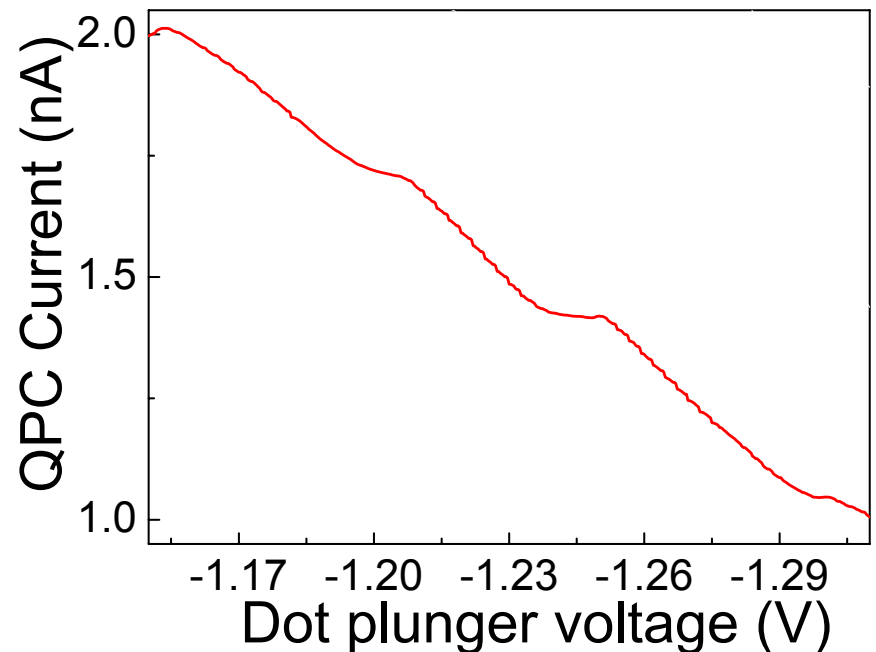
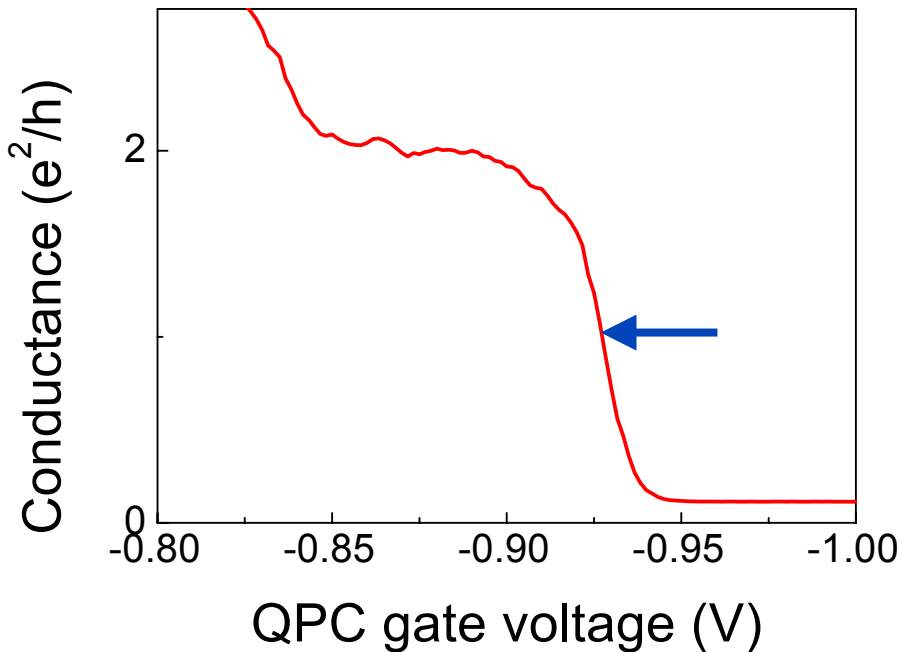
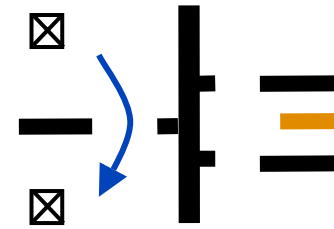
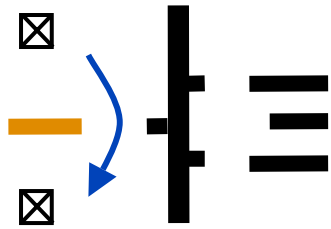

The last electron!

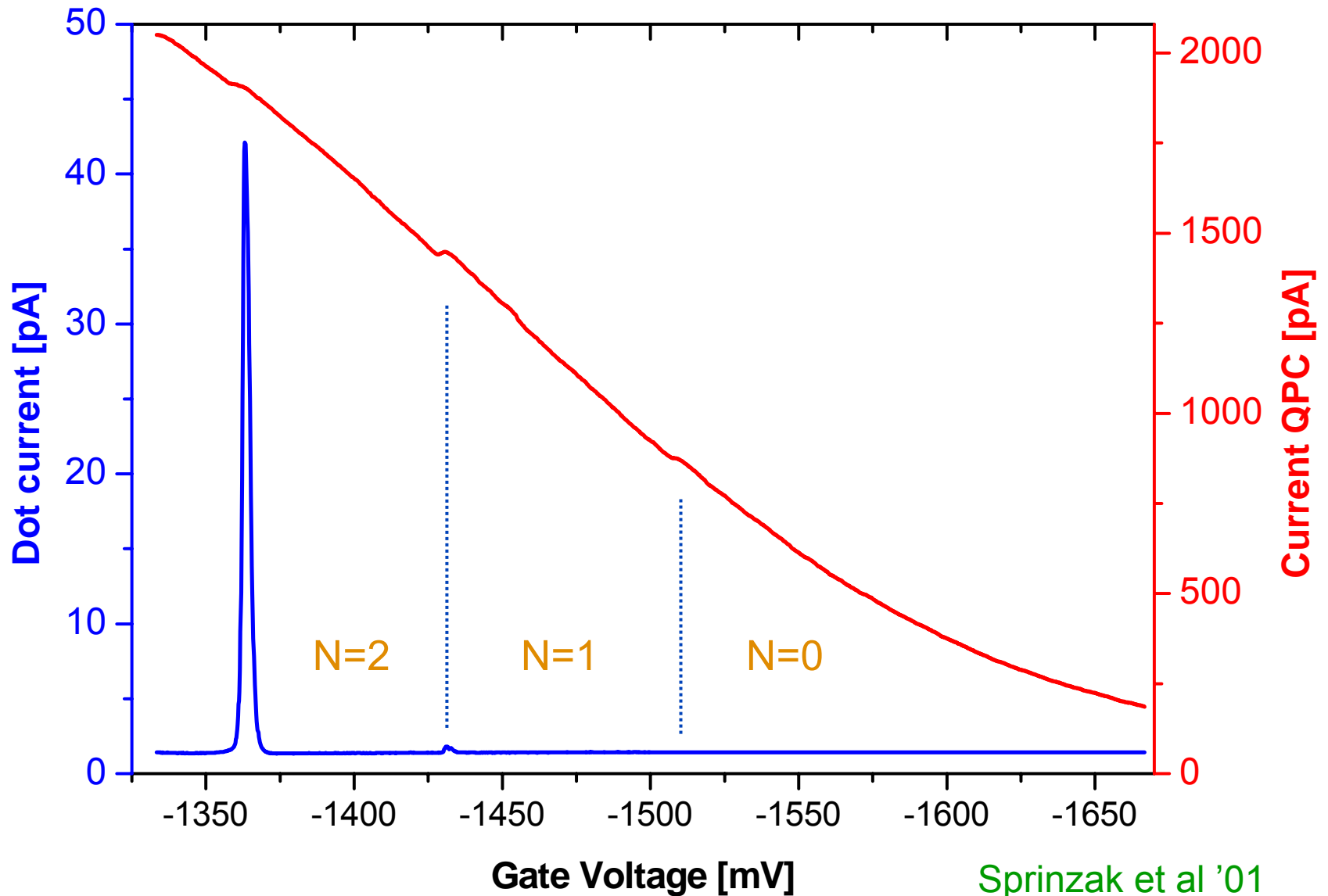

Sprinzak et al '01

Few-electron double dot design

Ciorga et al '99



Open design

Field et al '93
Sprinzak et al '01

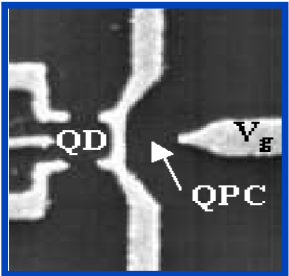

QPC for charge detection

GaAs/AlGaAs wafers:

{ NTT (T. Saku, Y. Hirayama)
Sumitomo Electric
Universität Regensburg (W. Wegscheider)

Elzerman et al., PRB 2003

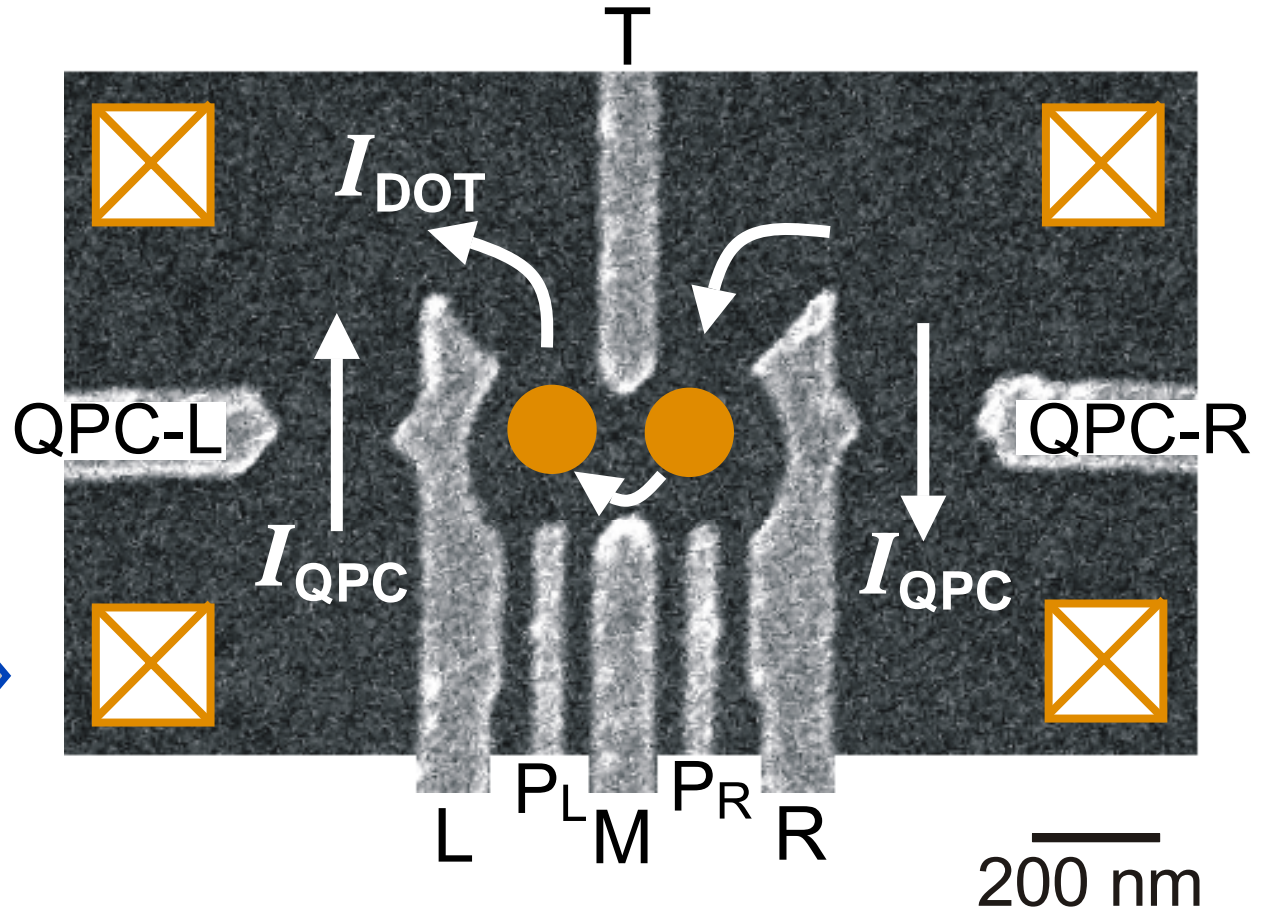

Few-electron double dot Measured via QPC

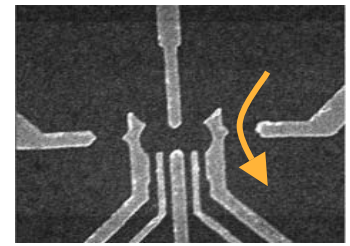

J.M. Elzerman et al., PRB **67**, R161308 (2003)

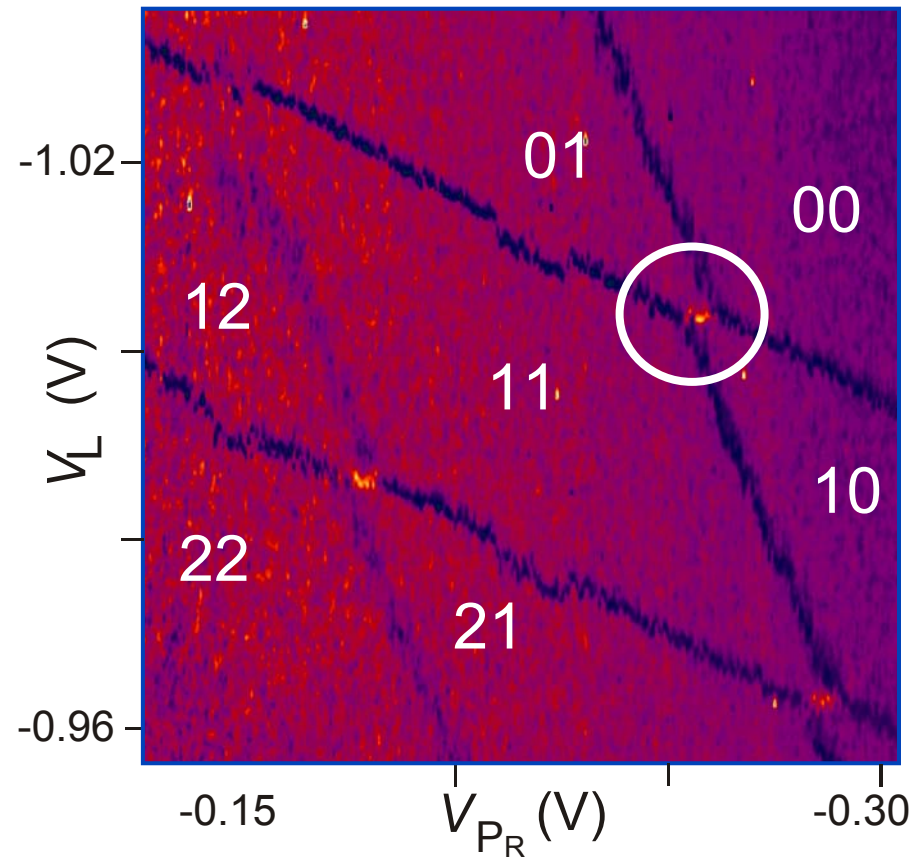
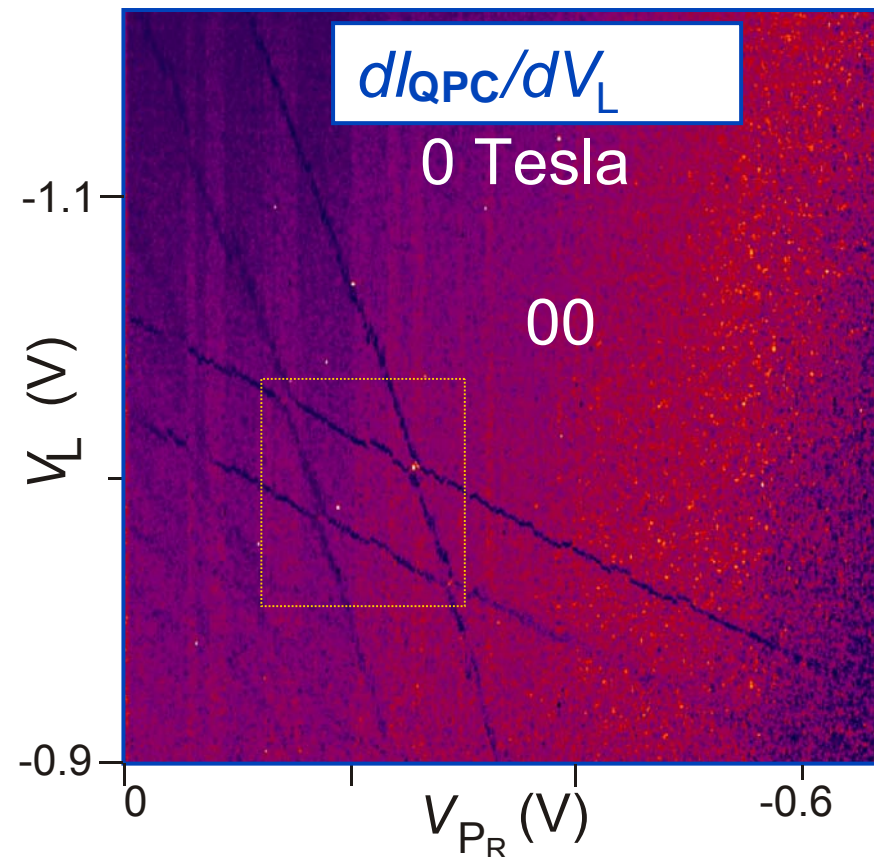

- Double dot can be emptied
- QPC can detect all charge transitions

Single electron tunneling through two dots in series

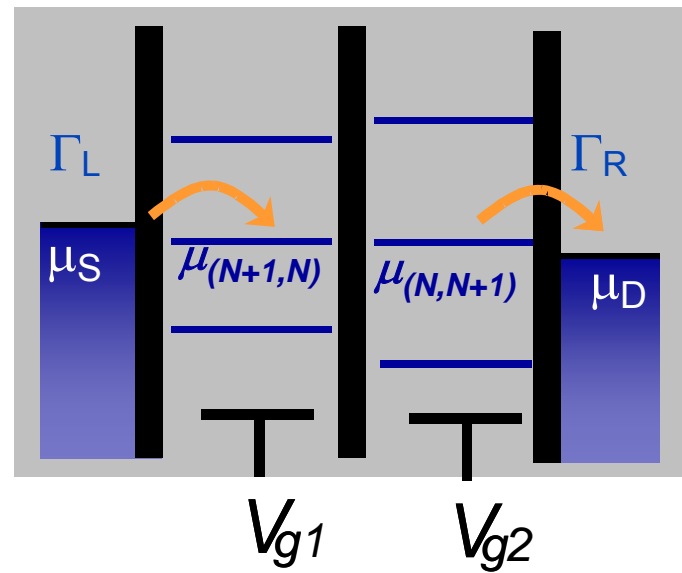

Few-electron double dot

Transport through dots

J. Elzerman et al., cond-mat/0212489

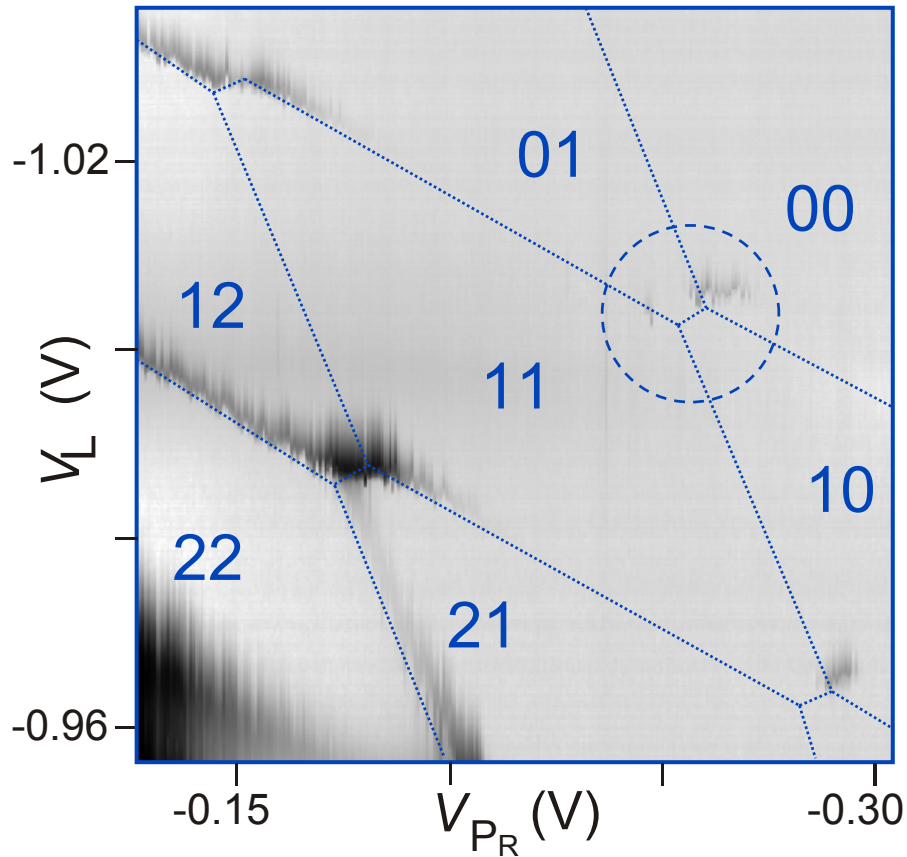
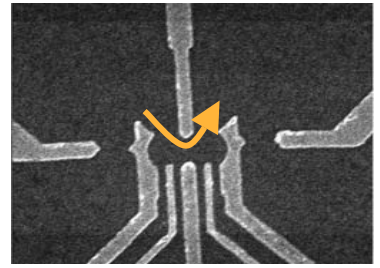

Peak height

< 1 pA

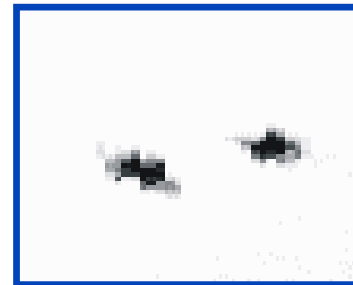

2 pA

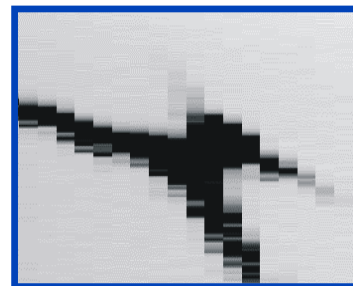

70 pA

Energy level spectroscopy at $B = 0$

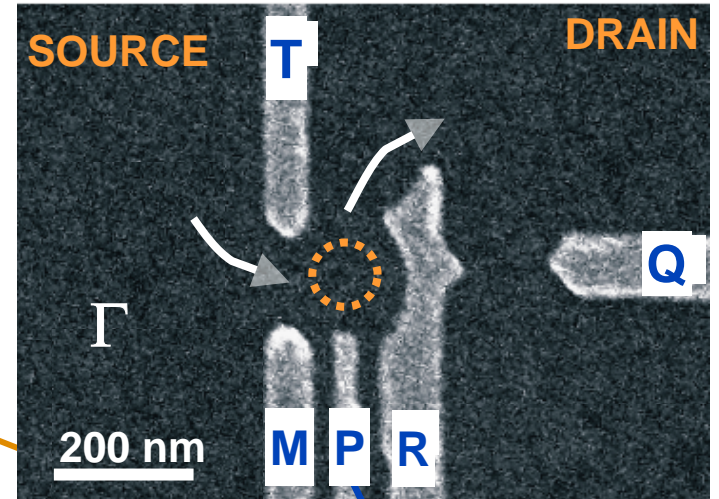
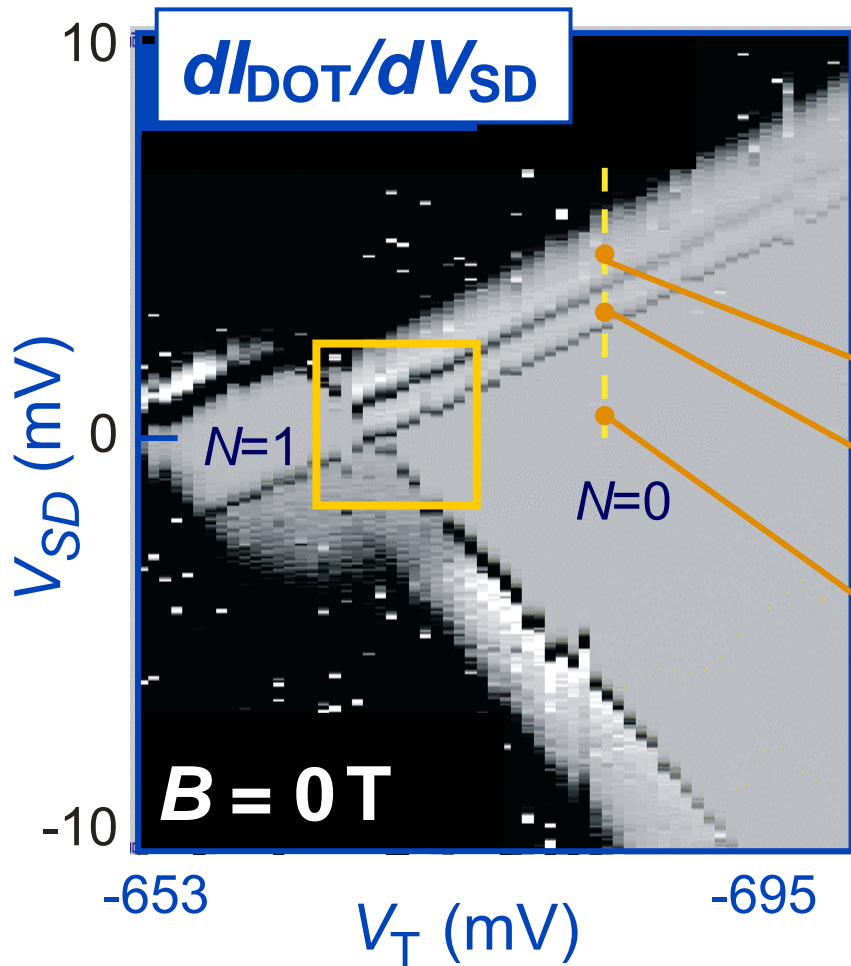

No transport

Ground state transport

Ground and excited state transport

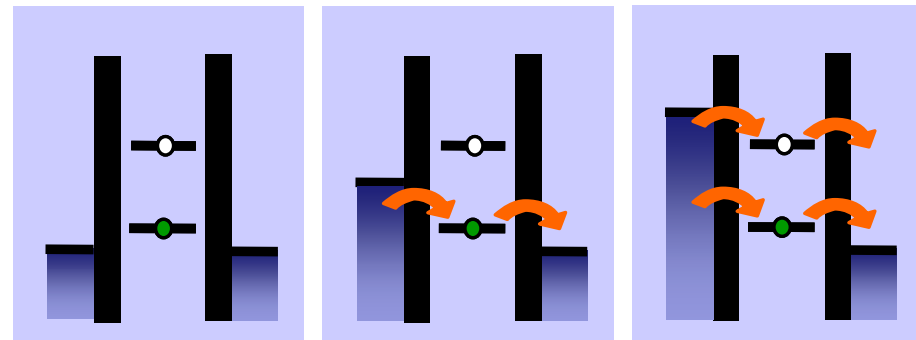

- $\Delta E \sim 1.1 \text{ meV}$
- $E_{\text{C}} \sim 2.5 \text{ meV}$

Single electron Zeeman splitting in $B_{||}$

Hanson et al, PRL 91, 196802 (2003)
Also: Potok et al, PRL 91, 016802 (2003)

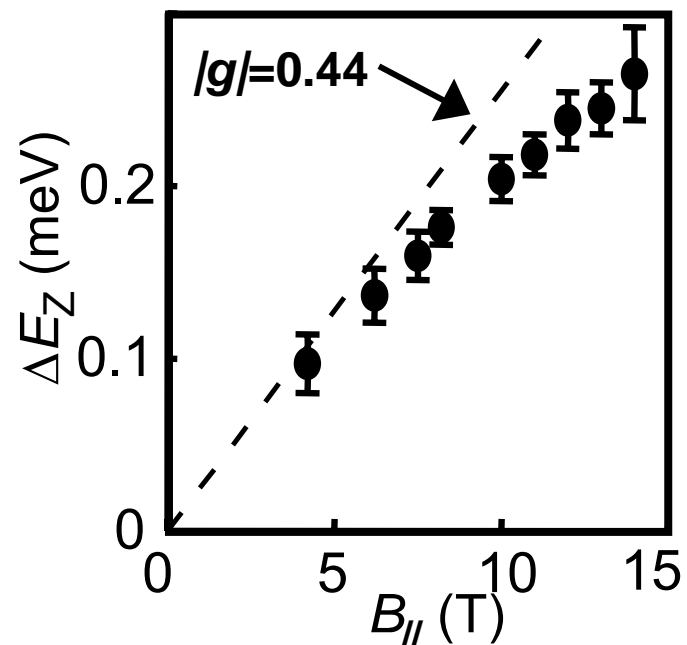
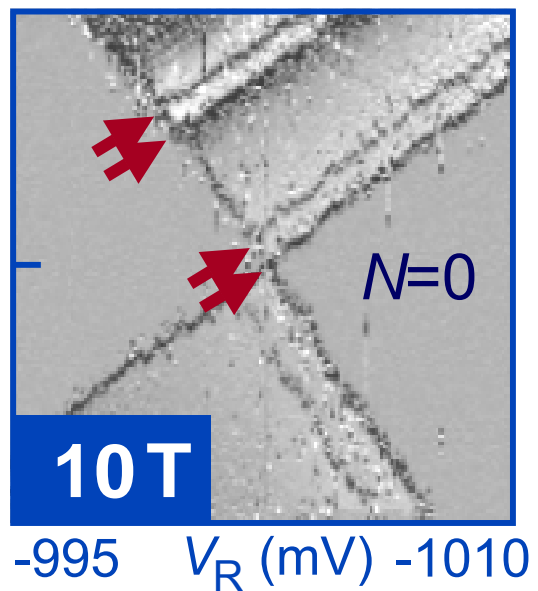
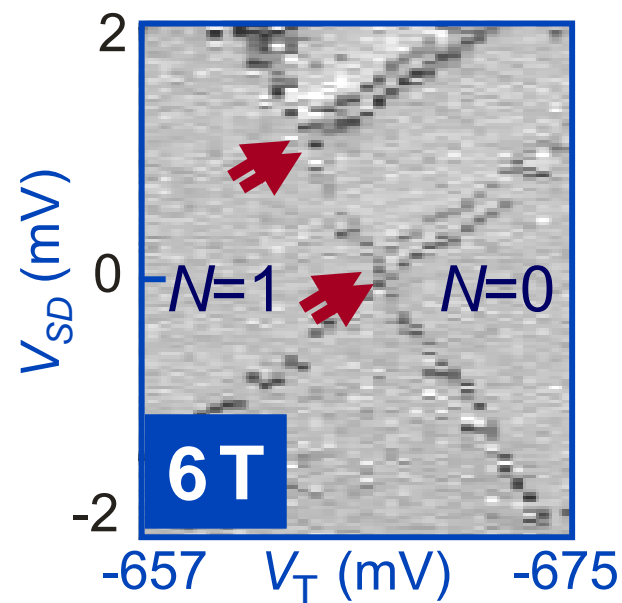
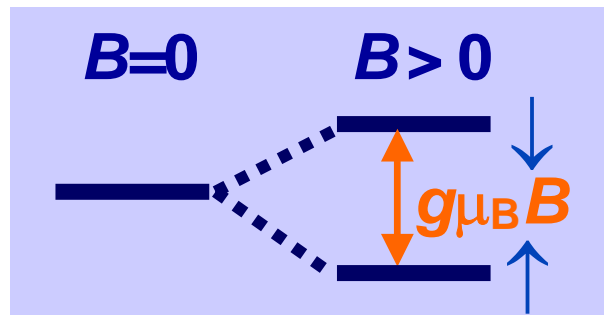
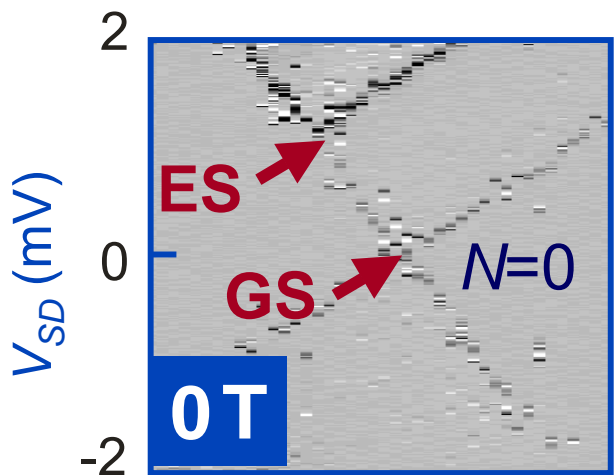

Initialization of a single electron spin

Method 1:
spin-selective
tunneling

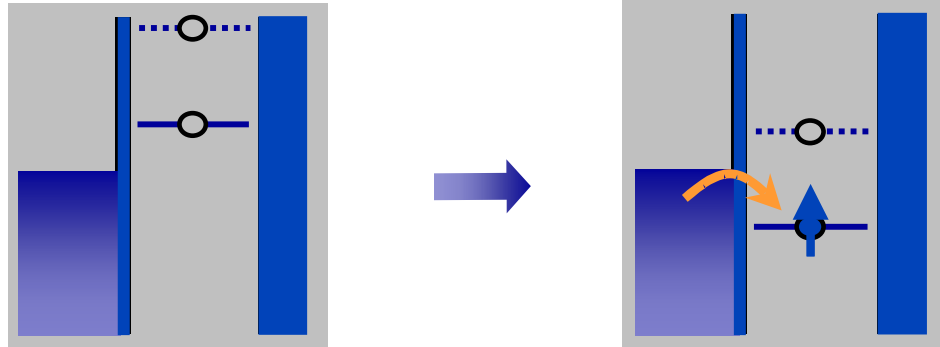

Method 2:
relaxation to
ground state

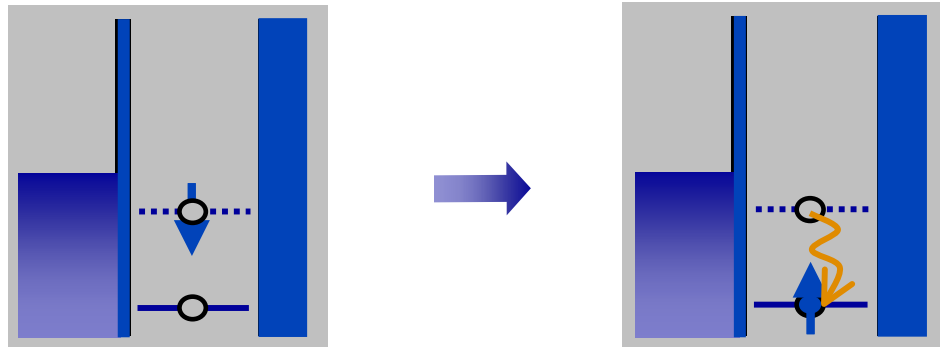

Spin qubits in quantum dots

Loss & DiVincenzo, PRA 1998

Vandersypen et al., Proc. MQC02 (quant-ph/0207059)

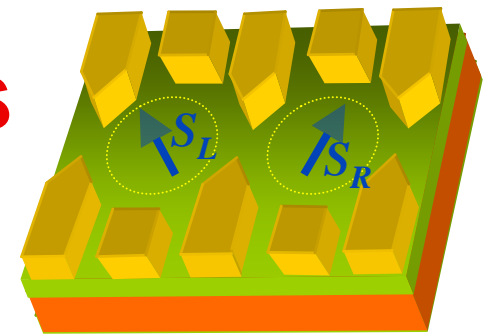

Initialization 1-electron, low T , high B_0

$$H_0 \sim \sum \omega_i \sigma_{zi}$$

Read-out convert spin to charge
then measure charge

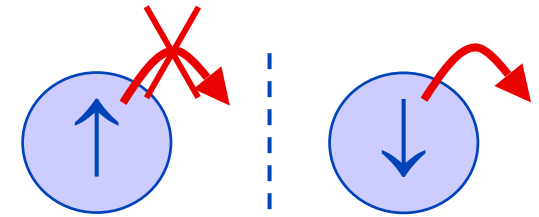

ESR pulsed microwave magnetic field

$$H_{\text{RF}} \sim \sum A_i(t) \cos(\omega_i t) \sigma_{xi}$$

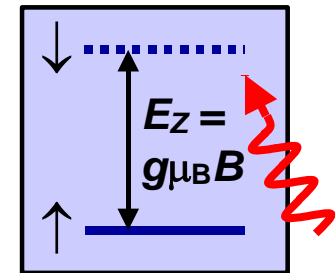

SWAP exchange interaction

$$H_J \sim \sum J_{ij}(t) \sigma_i \cdot \sigma_j$$

Coherence long relaxation time T_1
long coherence time T_2

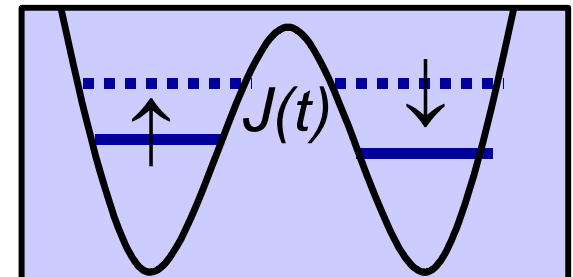

Spin read-out principle: convert spin to charge

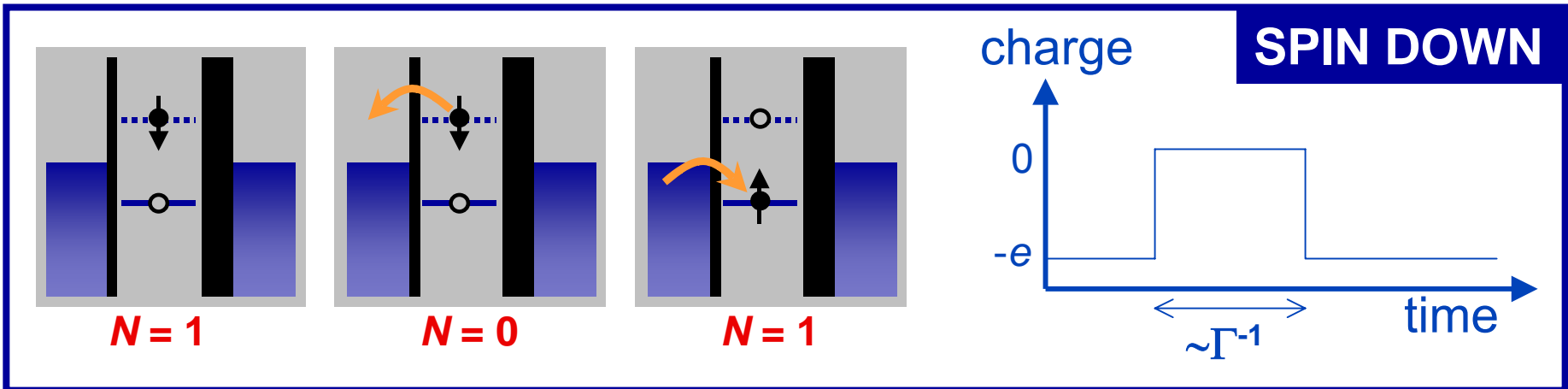

Observation of individual tunnel events

Vandersypen *et al*, APL 85, 4394, 2004
Also: Schlessler *et al*, 2004

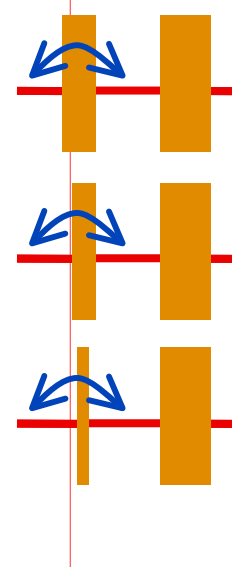
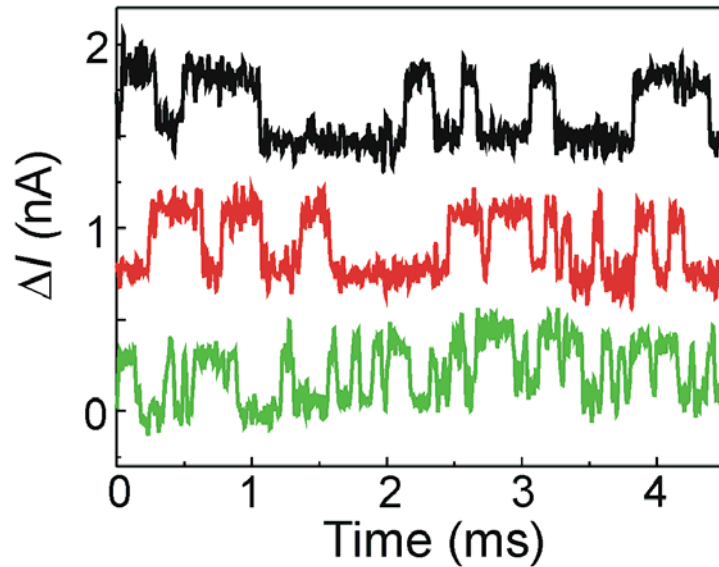
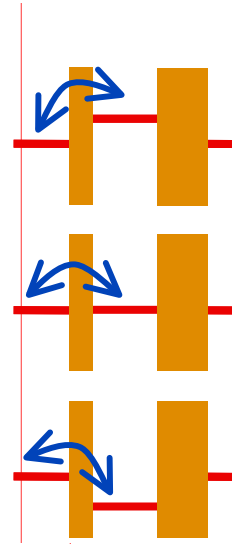
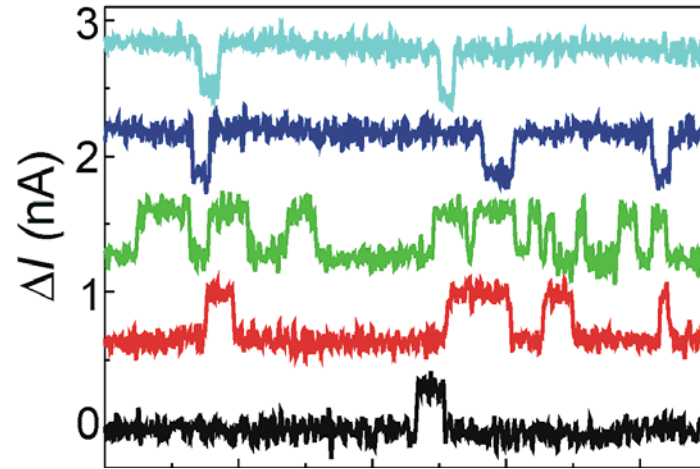
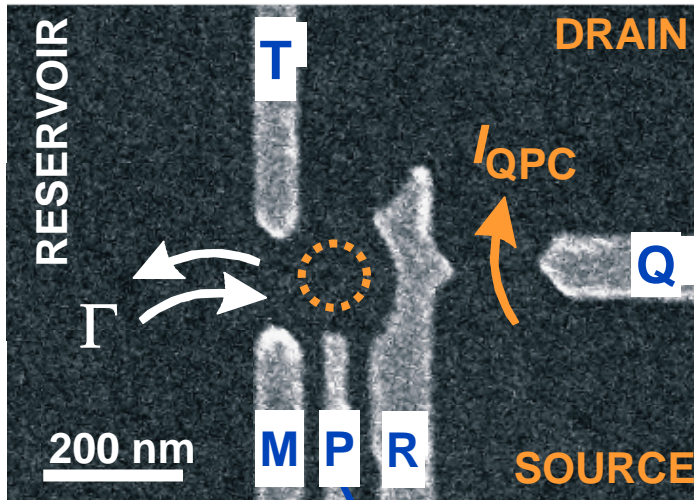

- $V_{SD} = 1 \text{ mV}$
- $I_{QPC} \sim 30 \text{ nA}$
- $\Delta I_{QPC} \sim 0.3 \text{ nA}$
- Shortest steps $\sim 8 \mu\text{s}$

Pulse-induced tunneling

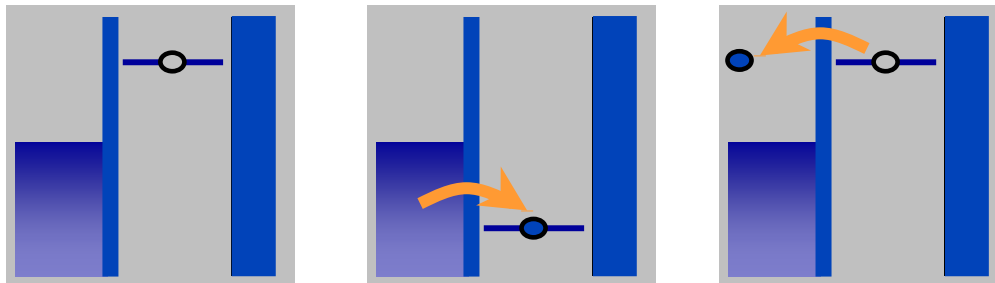
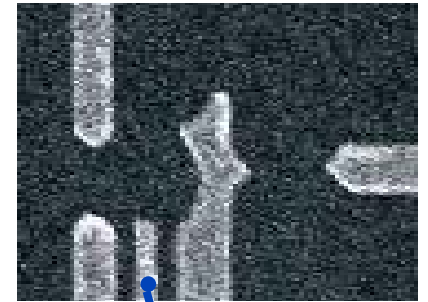
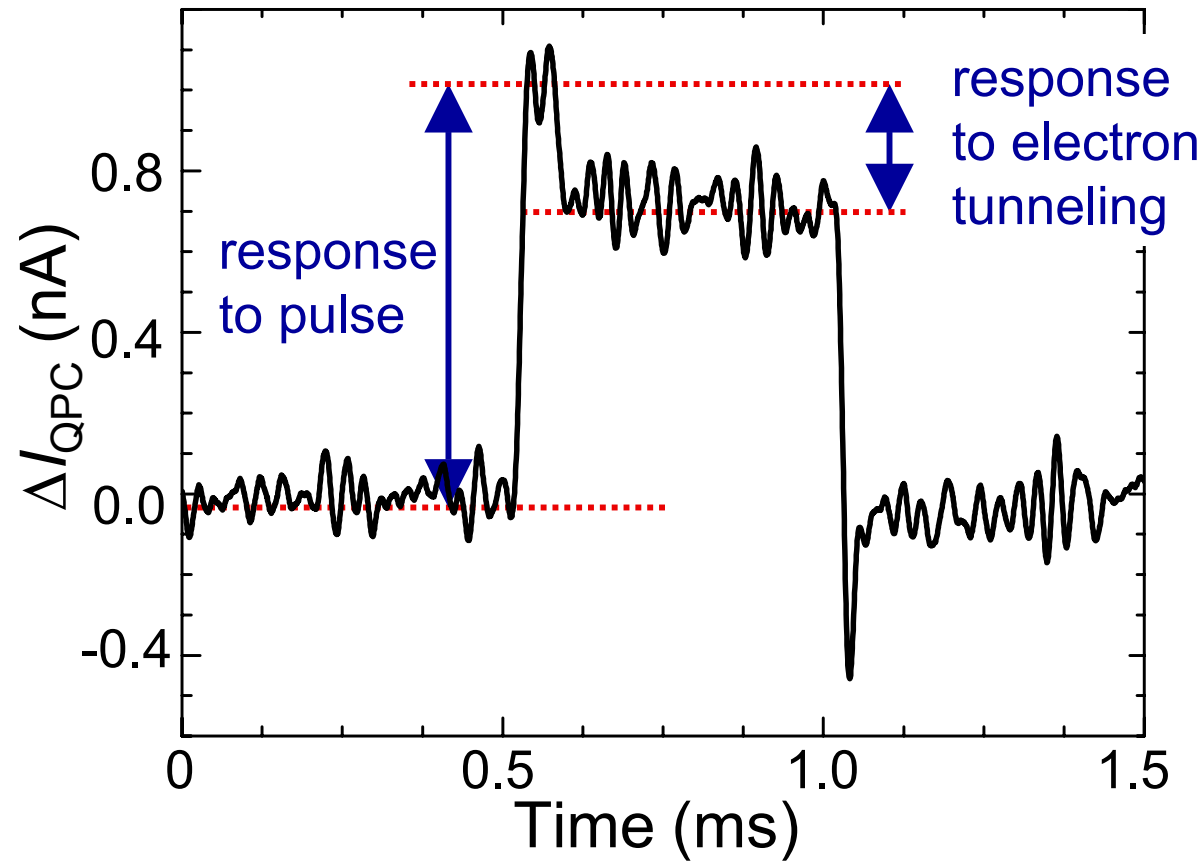

Spin read-out procedure

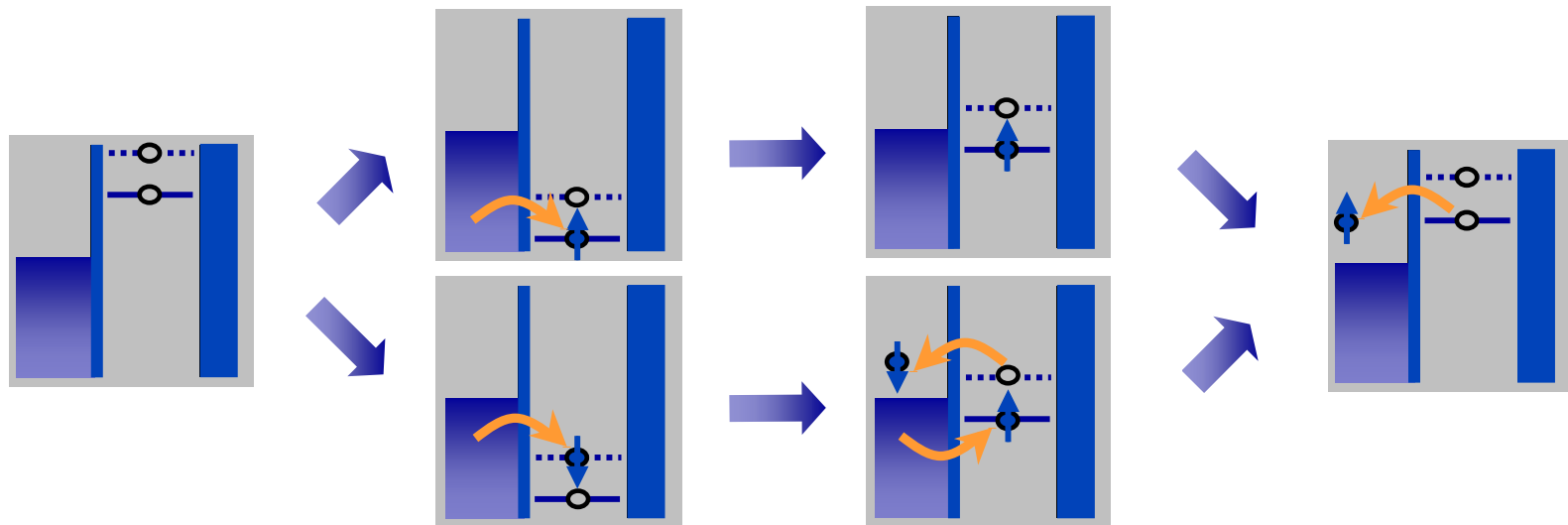
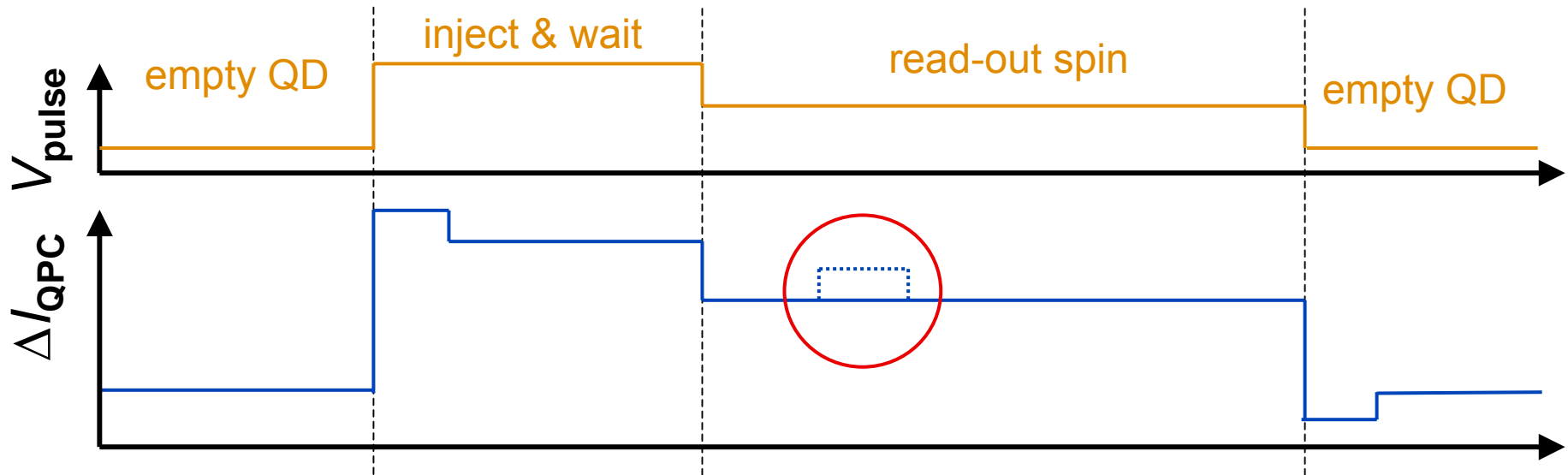

Spin read-out results

Elzerman *et al.*, Nature **430**, 431, 2004

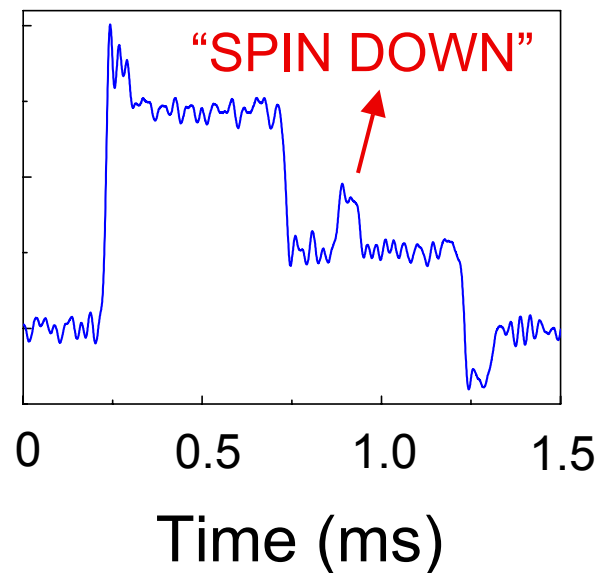
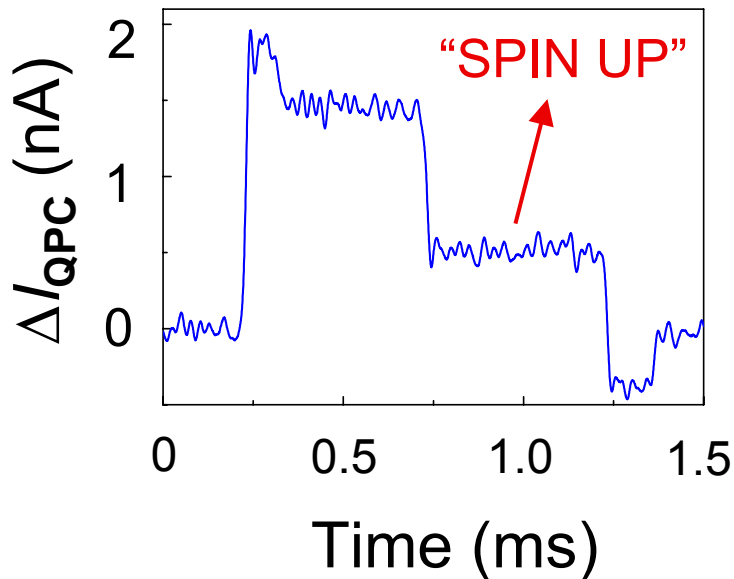
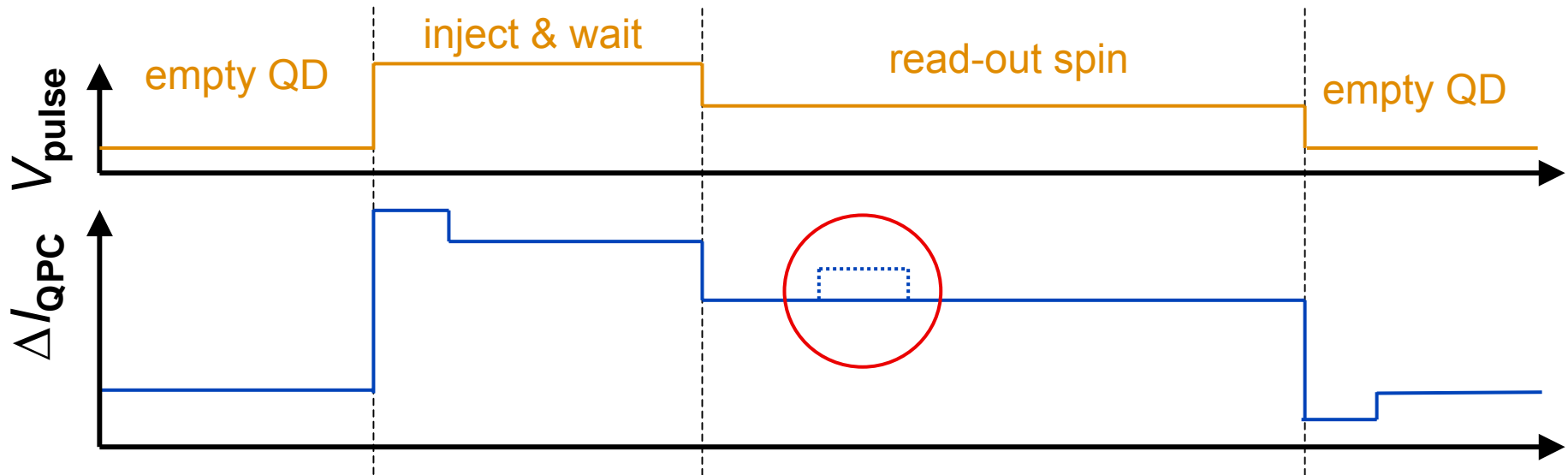

Spin qubits in quantum dots

Loss & DiVincenzo, PRA 1998

Vandersypen et al., Proc. MQC02 (quant-ph/0207059)

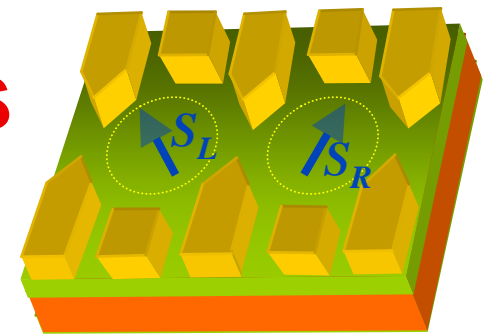

Initialization 1-electron, low T , high B_0

$$H_0 \sim \sum \omega_i \sigma_{zi}$$

Read-out convert spin to charge
then measure charge

ESR pulsed microwave magnetic field

$$H_{\text{RF}} \sim \sum A_i(t) \cos(\omega_i t) \sigma_{xi}$$

SWAP exchange interaction

$$H_J \sim \sum J_{ij}(t) \sigma_i \cdot \sigma_j$$

Coherence long relaxation time T_1
long coherence time T_2

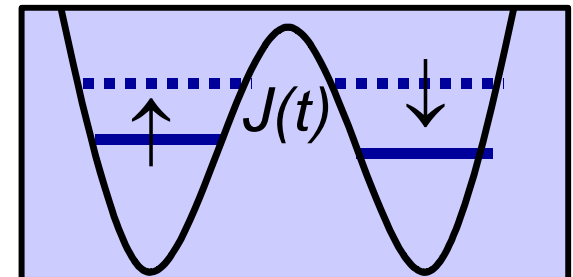
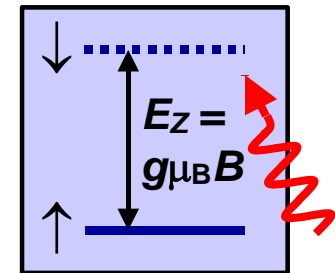

ESR detection in a single dot

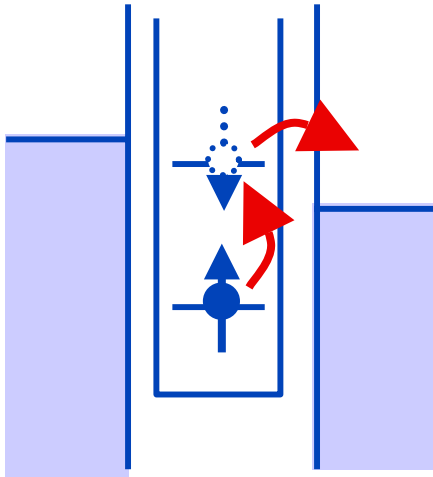

ESR lifts Coulomb
blockade

Engel & Loss, PRL 2001

Double dot in spin blockade for ESR detection

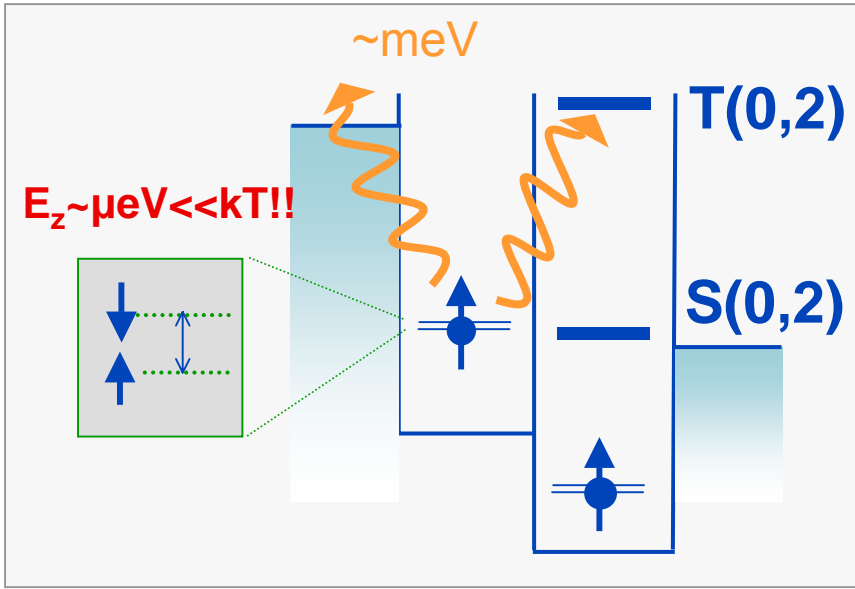

Advantage: *interdot transition instead of dot-lead transition*

- Insensitive to temperature
⇒ can use $B < 100$ mT, $f < 500$ MHz
- Insensitive to electric fields

ESR flips spin, lifts spin blockade

Combine Engel & Loss (PRL 2001) ESR detection with
Ono & Tarucha (Science 2002) spin blockade

ESR device design

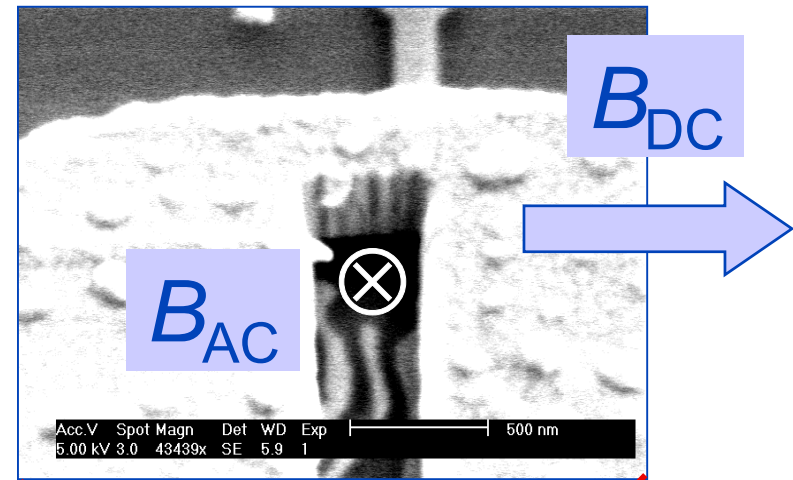
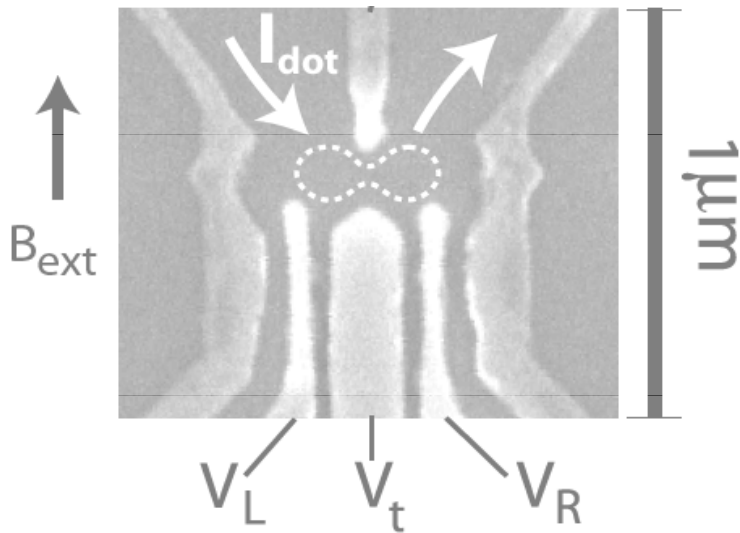

Gates $\sim 30\text{ nm}$ thick gold
Dielectric $\sim 100\text{ nm}$ calixerene
Stripline $\sim 400\text{ nm}$ thick gold

Expected AC current $\sim 1\text{ mA}$
Expected AC field $\sim 1\text{ mT}$
Maximize B_1 , minimize E_1

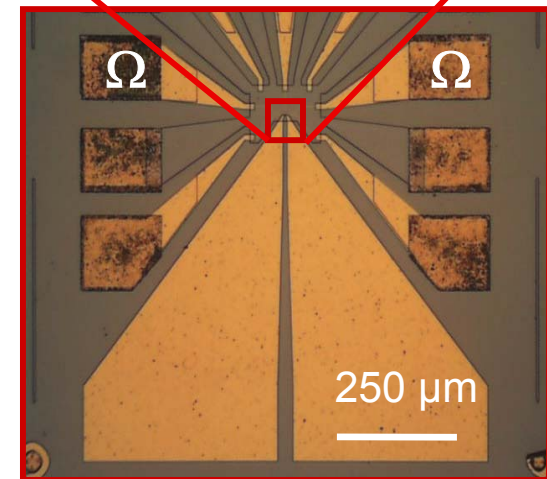

ESR spin state spectroscopy

ESR signature:

Sattelite peaks emerge at spin resonance condition ($|g\text{-factor}| \sim 0.35$)

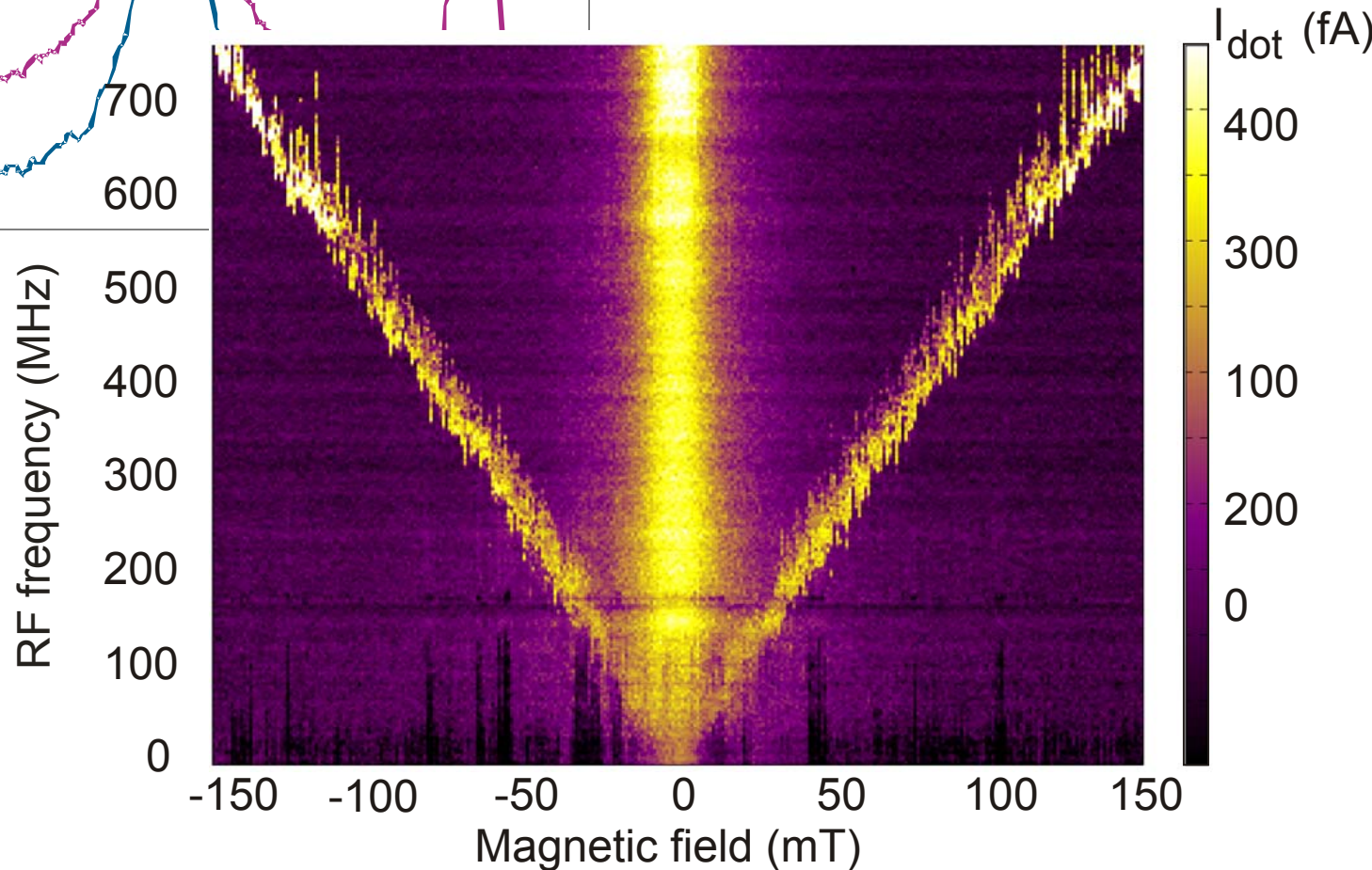
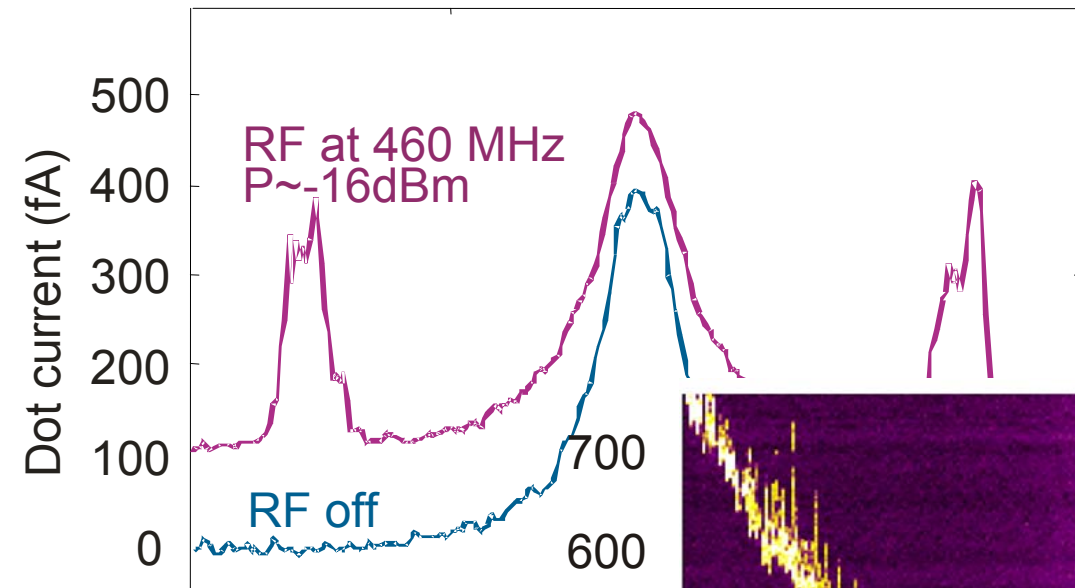

Koppens et al.,
Nature 2006

Coherent manipulation: pulse scheme

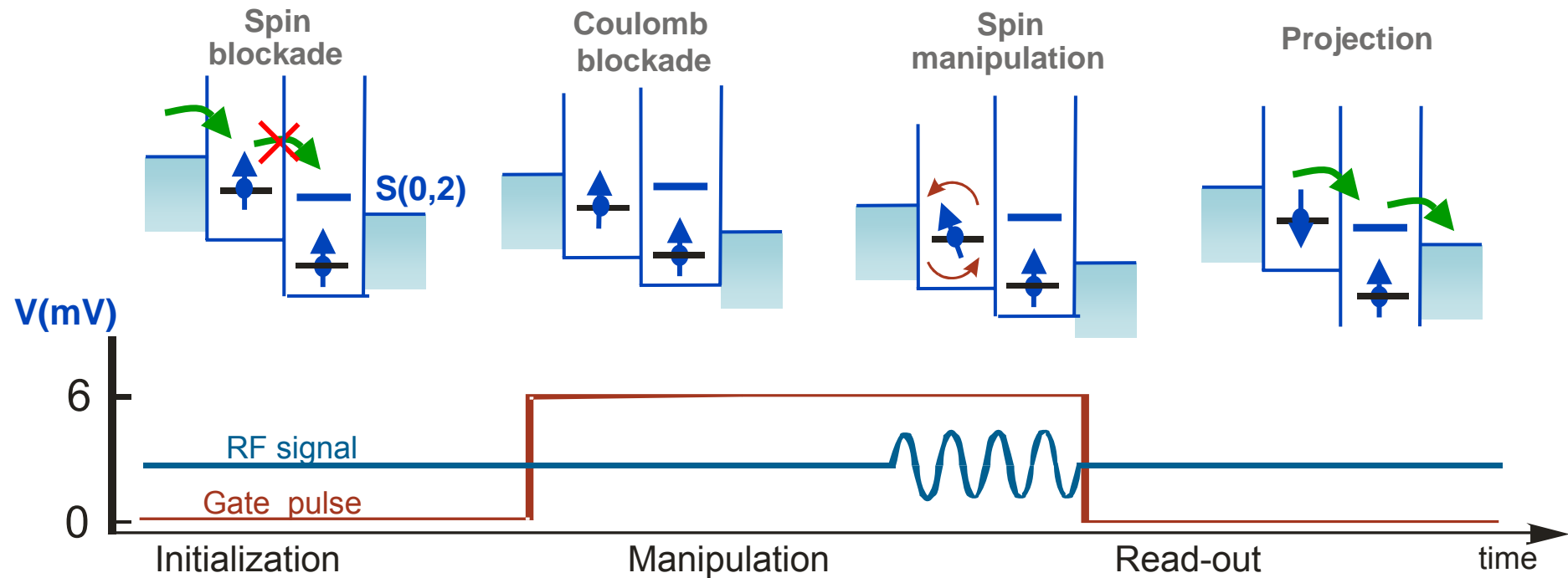

- Initialization in mixture of $\uparrow\uparrow$ and $\downarrow\downarrow$
- Measurement switched off (by pulsing to Coulomb blockade) during manipulation
- Read-out: projection on $\{\uparrow\uparrow, \downarrow\downarrow\}$ vs. $\{\uparrow\downarrow, \downarrow\uparrow\}$ basis

Coherent rotations of single electron spin!

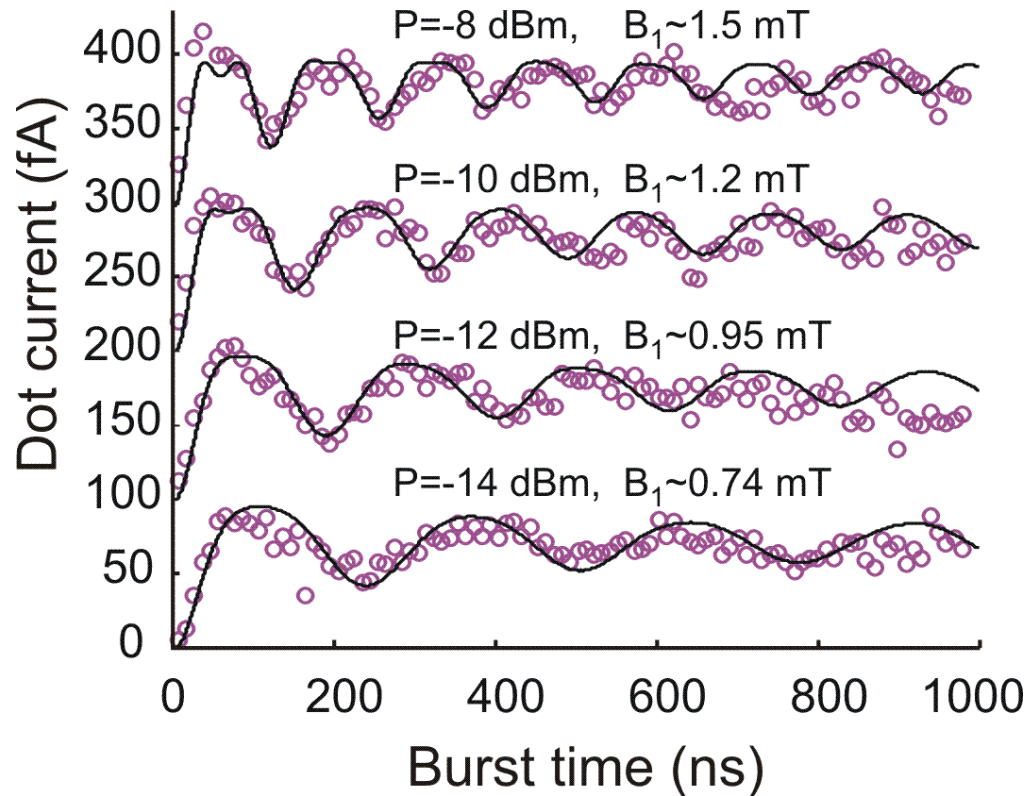

Koppens et al.
Nature 2006

- Oscillations visible up to $1\mu\text{s}$
- Decay non exponential \rightarrow slow nuclear dynamics (non-Markovian bath)
- Agreement with simple Hamiltonian

taking into account different resonance conditions both dots

Driven coherent oscillations

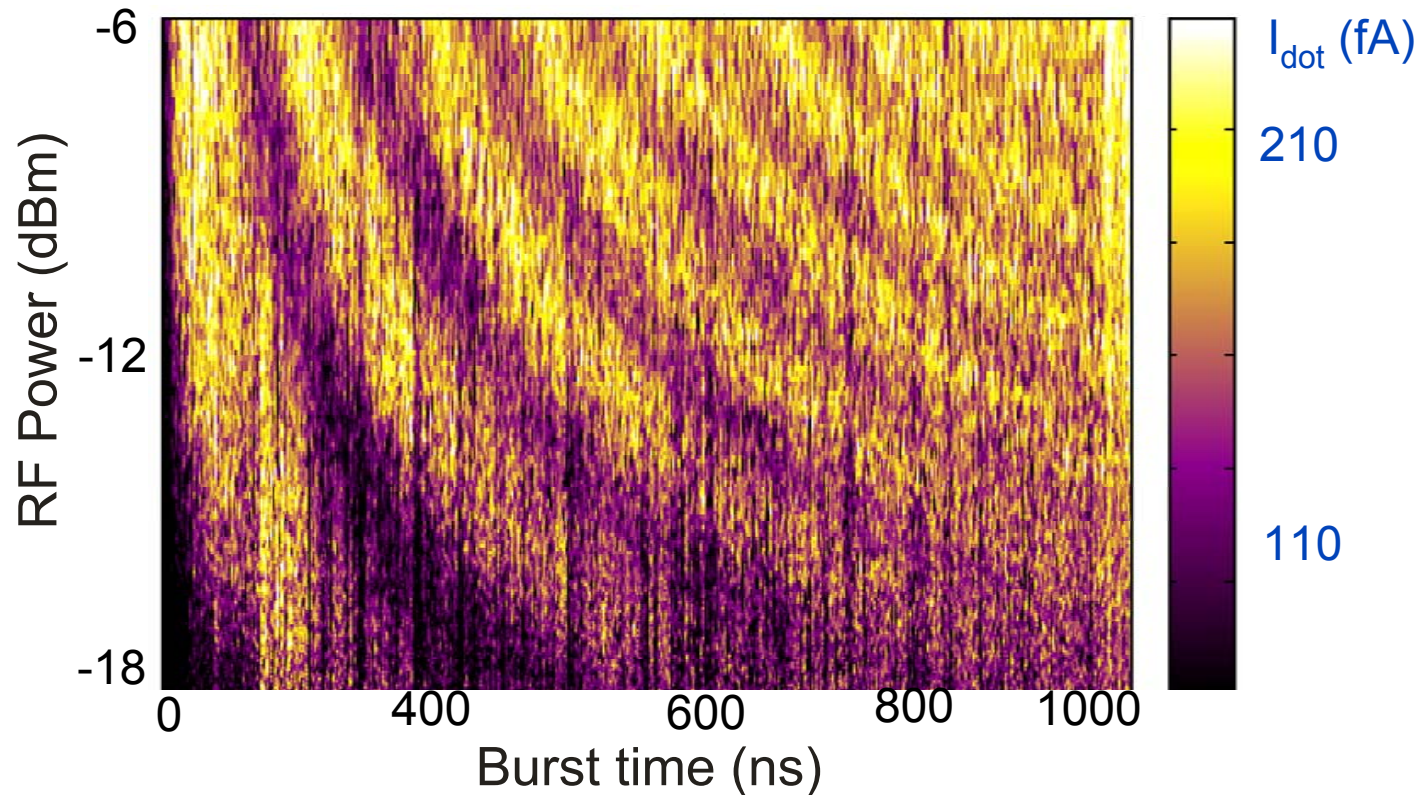

- Oscillation frequency $\sim B_{AC}$ \rightarrow clear signature of Rabi oscillations
 - $\pi/2$ pulse in 25ns
 - $\max B_1 = B_{AC}/2 = 1.9$ mT
 $B_{N,z} = 1.3$ mT
- } estimated fidelity $\sim 73\%$

Koppens et al.
Nature 2006

Spin qubits in quantum dots

Loss & DiVincenzo, PRA 1998

Vandersypen et al., Proc. MQC02 (quant-ph/0207059)

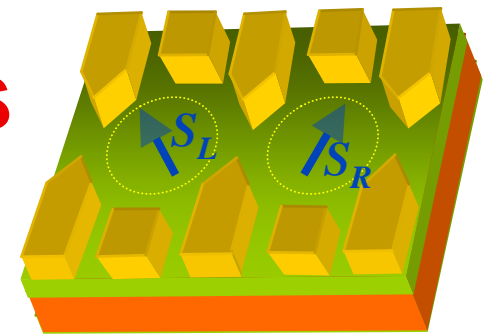

Initialization 1-electron, low T , high B_0

$$H_0 \sim \sum \omega_i \sigma_{zi}$$

Read-out convert spin to charge
then measure charge

ESR pulsed microwave magnetic field

$$H_{\text{RF}} \sim \sum A_i(t) \cos(\omega_i t) \sigma_{xi}$$

SWAP exchange interaction

$$H_J \sim \sum J_{ij}(t) \sigma_i \cdot \sigma_j$$

Coherence long relaxation time T_1
long coherence time T_2

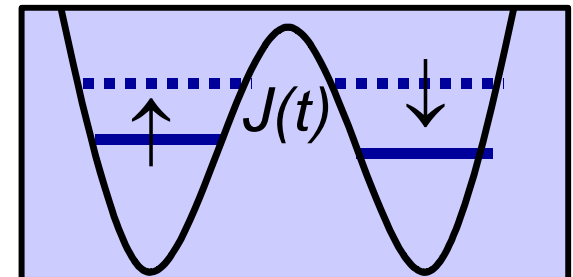
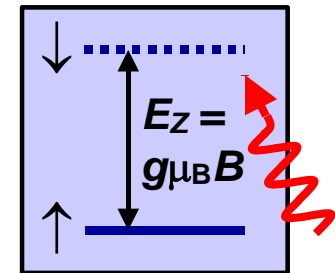

Coherent exchange of two spins

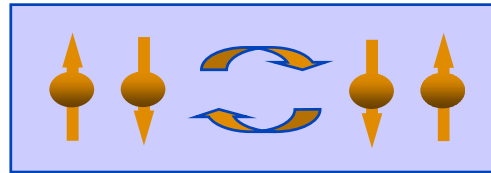
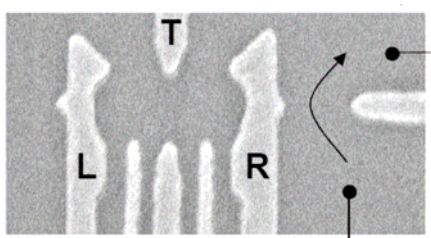

Petta *et al.*, Science 2005

- free evolution under exchange Hamiltonian
- swap^{1/2} in as little as 180 ps
- three oscillations visible, independent of J

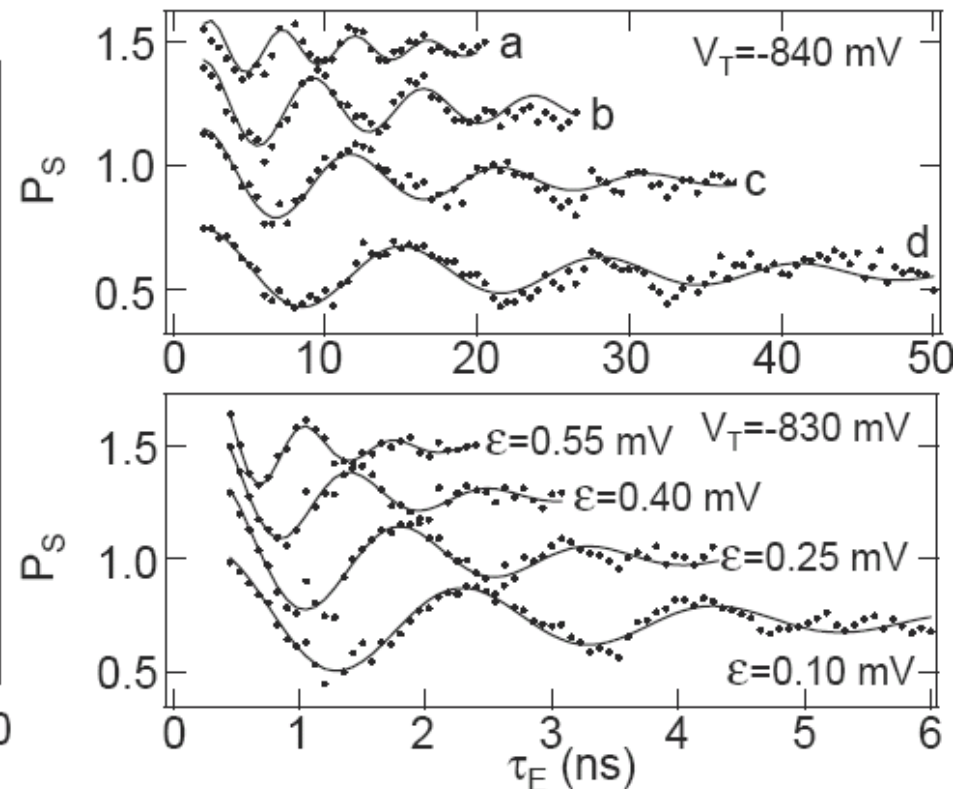
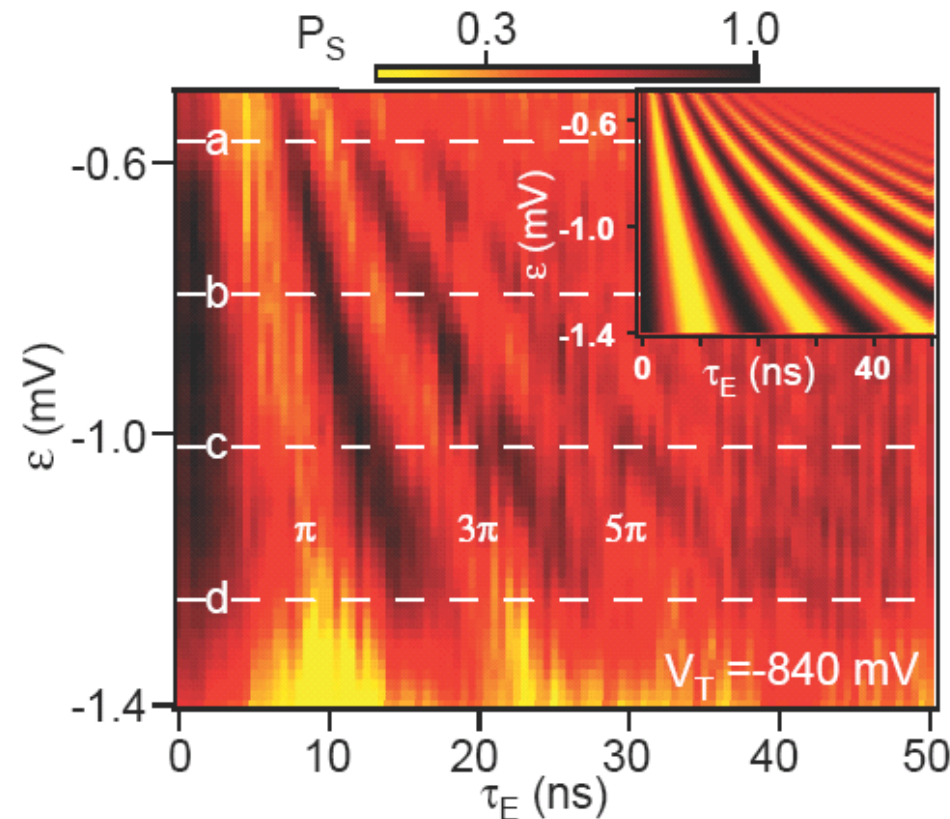

Spin qubits in quantum dots

- present status

Initialization

1 electron, low T , high B_0



$$H_0 \sim \sum \omega_i \sigma_{zi}$$

Read-out

convert spin to charge
then measure charge



ESR

pulsed microwave magnetic field



$$H_{RF} \sim \sum A_i(t) \cos(\omega_i t) \sigma_{xi}$$

SWAP

exchange interaction



$$H_J \sim \sum J_{ij}(t) \sigma_i \cdot \sigma_j$$

Coherence

measure coherence time



$$T_1 \sim 1 \text{ ms}; T_2 > 1 \mu\text{s}$$

